

BUILDING A PARADE FLOAT 101





NWSU HOMECOMING THEME FOR 2023

"Rock Rangers Rock... Homecoming Tour 2023"

DATES: October 5-7



OUR OPPONENT

- Harding University
- Searcy, Ark.
- COLORS: Black & Gold
- MASCOT: the Bisons



FLOAT PRIZES

1st place - \$200

2nd place - \$150

3rd place - \$100

- President's award (best overall) \$100.00
- Alumni association award (best display of ranger spirit) \$75.00

FLOAT REIMBURSEMENTS

- Reimbursements of up to \$200 may be provided to the first 5 campus and non-profit off-campus organizations which register for it at the conclusion of homecoming.
- These groups must provide receipts verifying expenses no later than Tuesday, November 8th by noon to Tara Hannaford, Financial Aid Office, Herod Hall, room 113.

FLOAT REQUIREMENTS

- In order to qualify for reimbursement, each organization must:
 - Review the float building workshop presentation online
 - Turn-in float application with sketch/design including details for approval by noon, **Wednesday, October 4** to Shannon Leaper, NWOSU J.W. Martin Library

RULES AND REGULATIONS

- Float must be built on a trailer at least 12 feet in length.
- The float must have some design and the group must actually build something. There must be some type of structure on the trailer. (Create a structure out of chicken wire, cardboard, etc.)
- The float needs to have more than just words on skirting and people standing on a trailer.

RULES AND REGULATIONS CONT.

- Float should be pumped with napkins, weaved with tissue paper, or covered with floral sheeting, fringe, etc.
- Skirting on the trailer is required. The wheels of the trailer should NOT show.
- Moving parts, sound, smoke, etc are all encouraged.
- Encourage all of your members to dress in theme and walk in front and behind your float.
- The float can be no taller than 16 feet.
- The float must follow the theme.

MOST IMPORTANTLY

- DON'T LET THESE REQUIREMENTS HINDER YOUR CREATIVITY. IF YOU HAVE AN IDEA, ASK IF IT WILL WORK. ALL EXCEPTIONS TO THESE RULES SHOULD BE APPROVED BY THE HOMECOMING FLOAT COMMITTEE.

BEGINNING CONSTRUCTION

- Supplies you might need!
 - Staple gun
 - Nails
 - Wire
 - Chicken wire
 - Construction grade wood/plywood

TRAILERS

- **LOW-BOY TRAILERS**

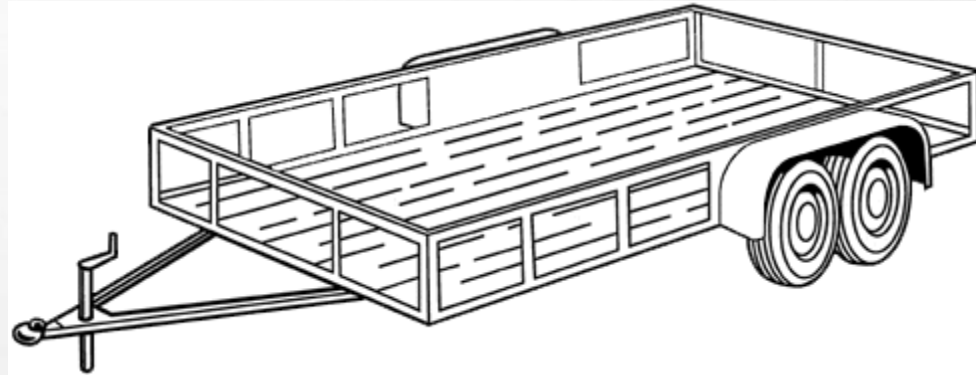

- **HAY TRAILER**

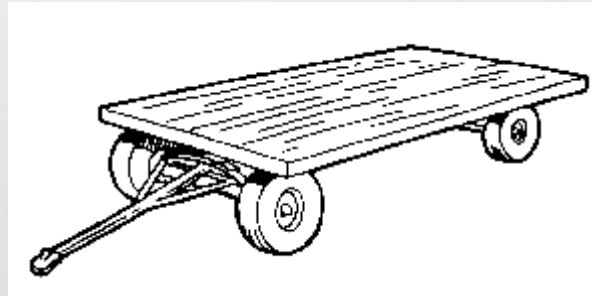

LOW-BOY TRAILERS

- Pallets can be used to build a partial or full sub-structure to elevate the platform of the float.
- It is a good idea to build a partial deck that will be even with the top rails of the float. You can use good quality pallets to make a platform. Make sure the pallets are firmly fastened to the bed of the float.

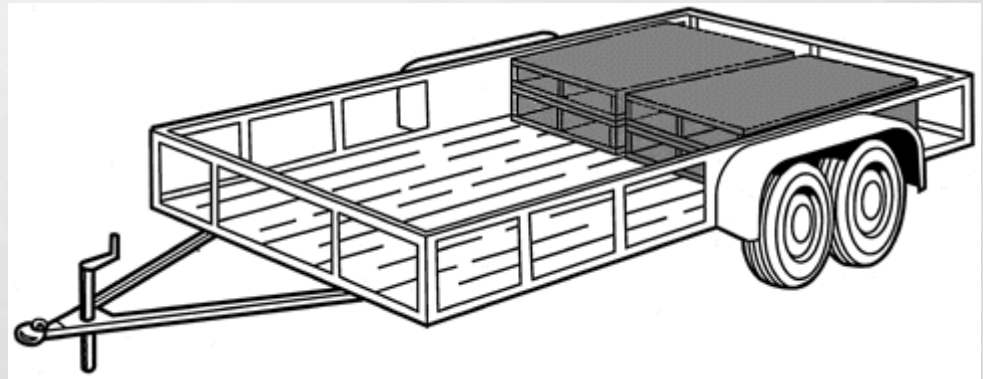

LOW-BOY TRAILERS

- Next, lay sheet plywood over the pallets. Now you will have a platform for your props and an area in the bed where float riders can stand or sit.

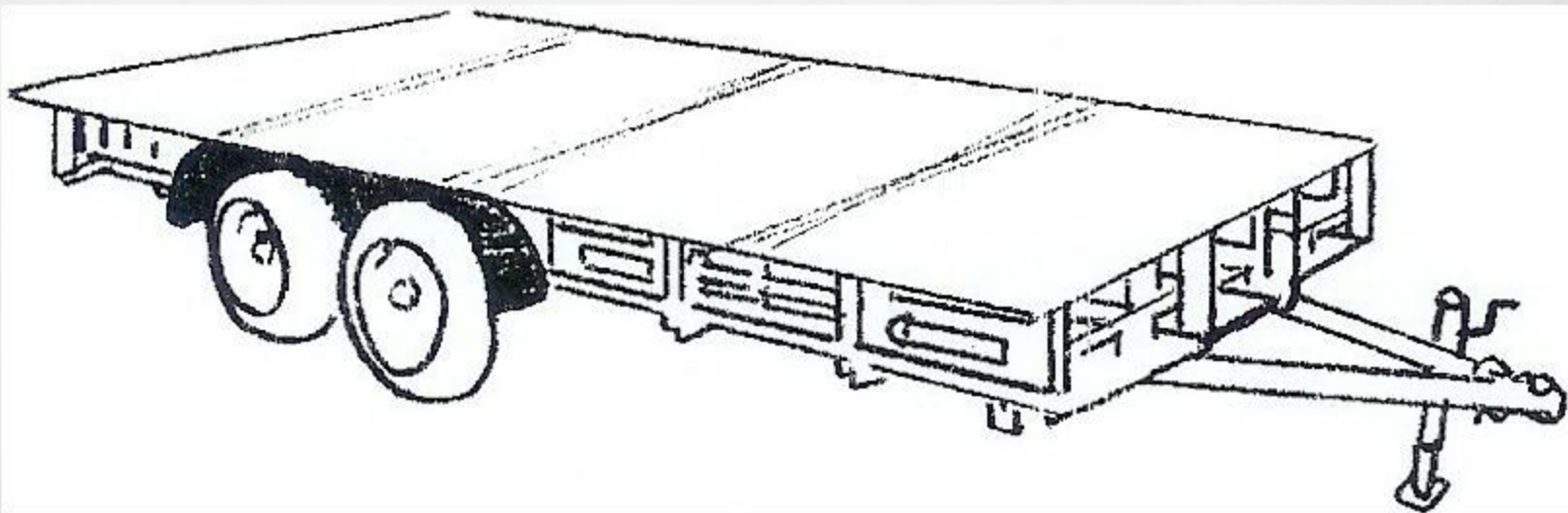

LOW-BOY TRAILERS

- Apply sides to deck... Use “L” shaped brackets available at most hardware stores. Apply wood skirts to top of wood deck with “L” brackets; sides should remain 14” from bottom of side deck to the ground.

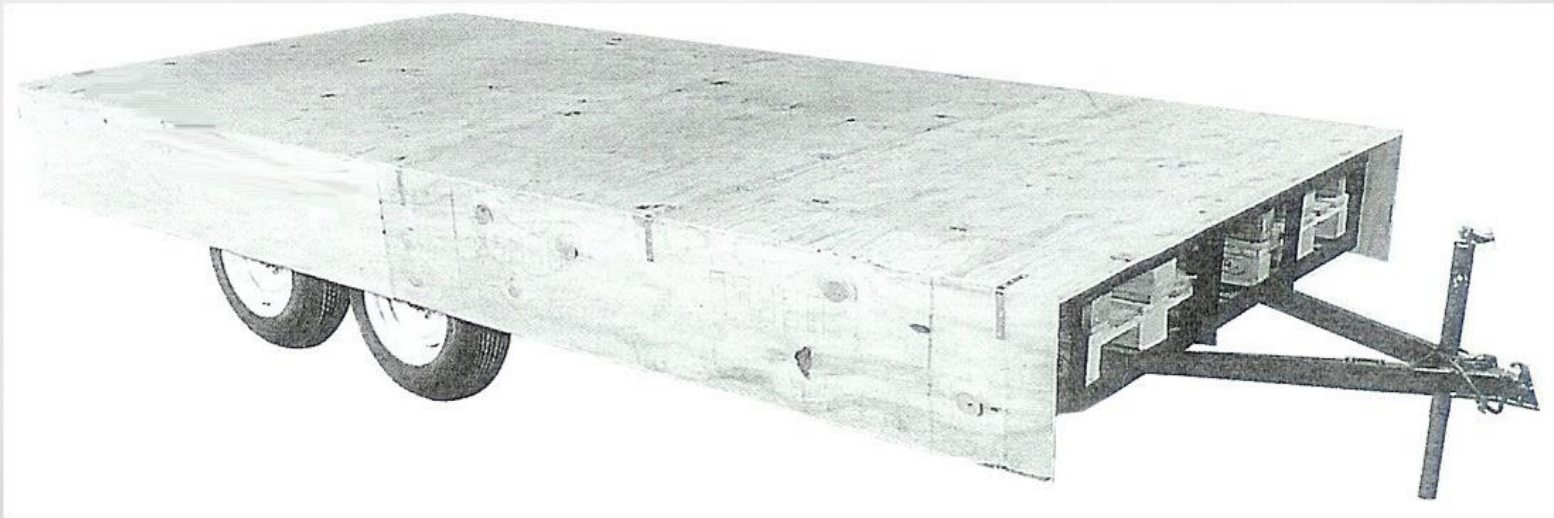

NOW YOU'RE READY TO DECORATE YOUR FLOAT!

Fringe



Festooning



**Plastic
Decorating
Pomps**



Vinyl & Metallic Floral Sheeting



EXAMPLES



DECORATING YOUR FLOAT

- Attach floral sheeting to trailer with staple gun.

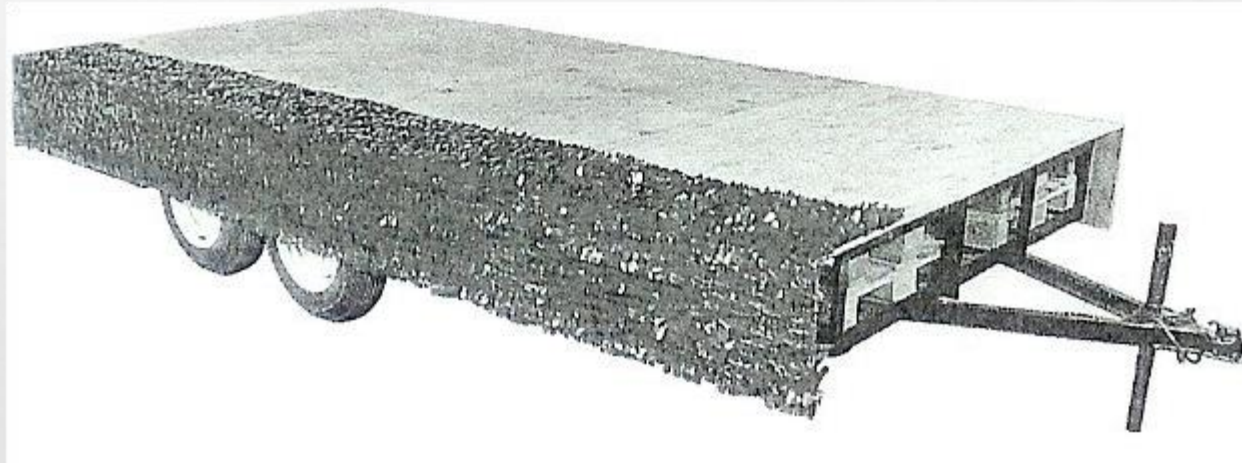

DECORATING YOUR FLOAT

- Then add fringe to the floral sheeting

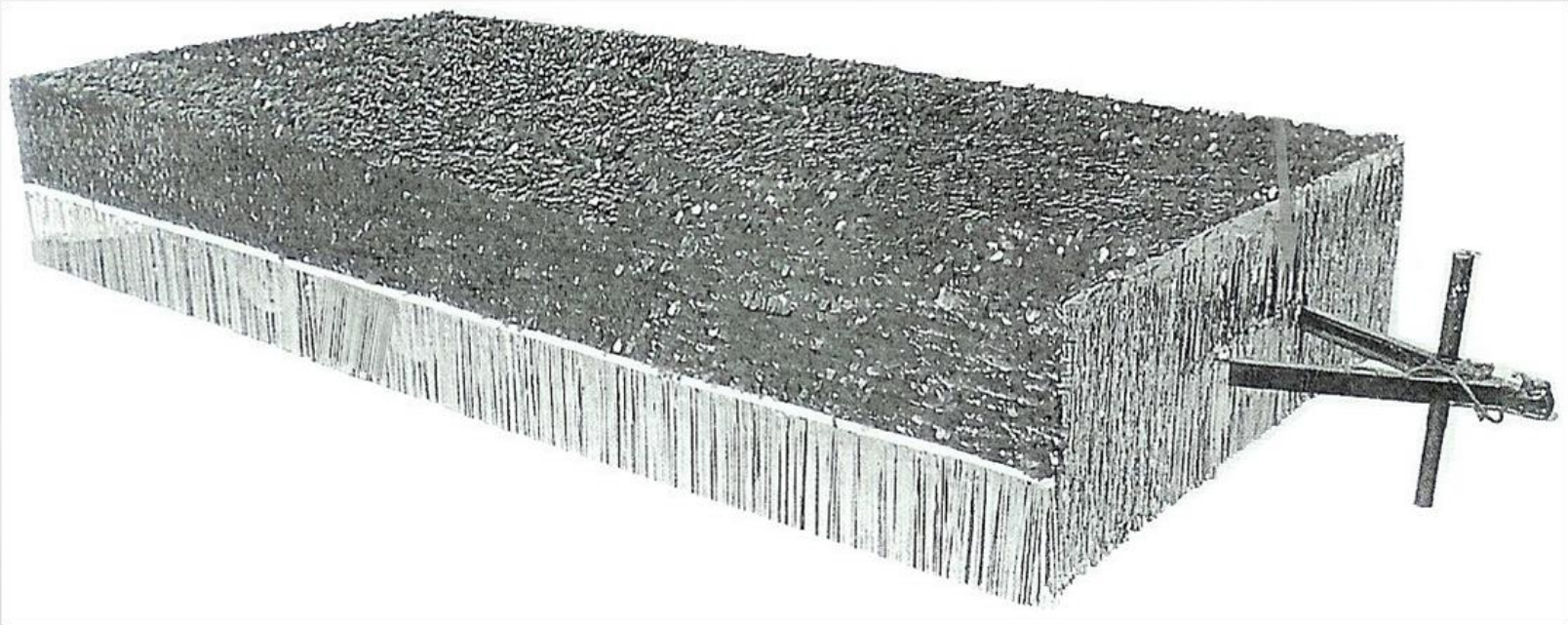

DECORATING YOUR FLOAT

- Use festooning to hide the seam between the floral sheeting and the fringe.

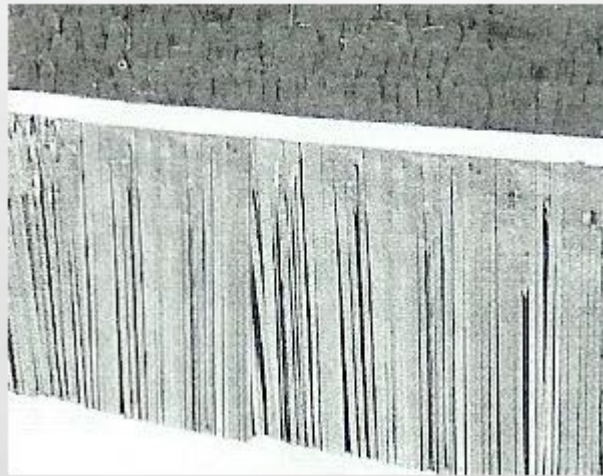

Seam

FINISHED PRODUCT



OTHER OPTIONS IN DECORATING

- Chicken wire
- Pomping
- Tissue paper



OTHER SUGGESTIONS

- Line sides of bed with chicken wire.
- Use newspaper/butcher paper
- Blend flour and starch
- Dip newspaper into mix
- Paste onto chicken wire
- Allow to dry, then spray paint

EXAMPLES



EXAMPLES

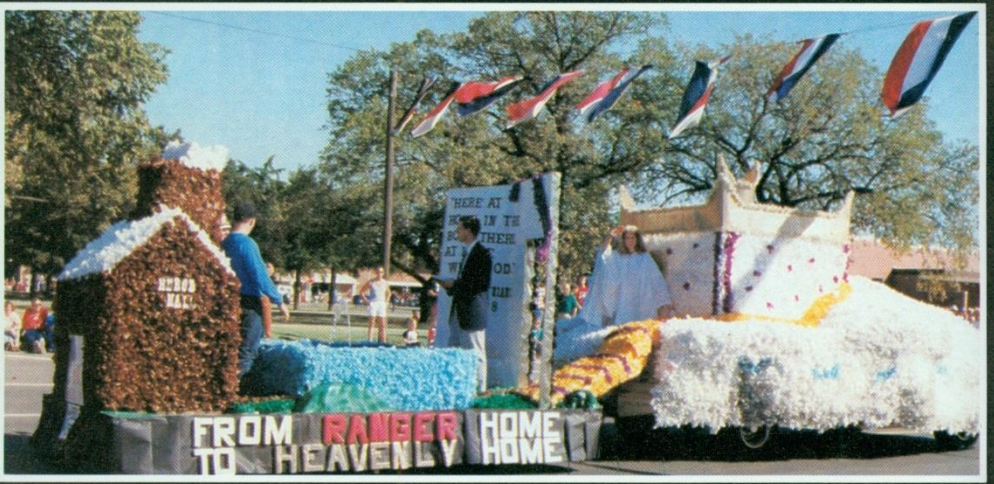

EXAMPLES



EXAMPLES



EXAMPLES



FILLING THE FLOAT WITH A STRUCTURE

- Build the frame(s) of the object(s) (use wood, PVC pipe, chicken wire, etc...)
- String with chicken wire to fill out.
- Use cloth, paper mache, paint, etc...
- Securely fasten frame to the base

TIPS

- Decorate using pomp and people.
- Have movement to catch people's eye.
- Use balloons- cheap and easy
- Make your float colorful.
- Use original decorations (i.E. Umbrellas, movement, music, etc...)

DON'T DO:



REMINDERS

- Supplies – local, ordering, helpful links, etc.
- Plan ahead
- Organizations team up
- Armory
- Utilize advisers and people that you know
- Be creative and have fun! 😊

DO YOU HAVE ANY QUESTIONS?

CONTACT:

DR. DAVID PECHA

580 – 327 – 8528

DMPECHA@NWOSU.EDU

MRS. SHANNON LEAPER

580 – 327 – 8570

SELEAPER@NWOSU.EDU